



RT6 Electronic Thermostat

- 1-Stage Heat/1-Stage Cool Systems
- Configurable to: 2-stage heat pump
- Large Display With Backlight
- Selectable Fahrenheit or Celsius



Installation, Operation & Application Guide



Parts Diagram

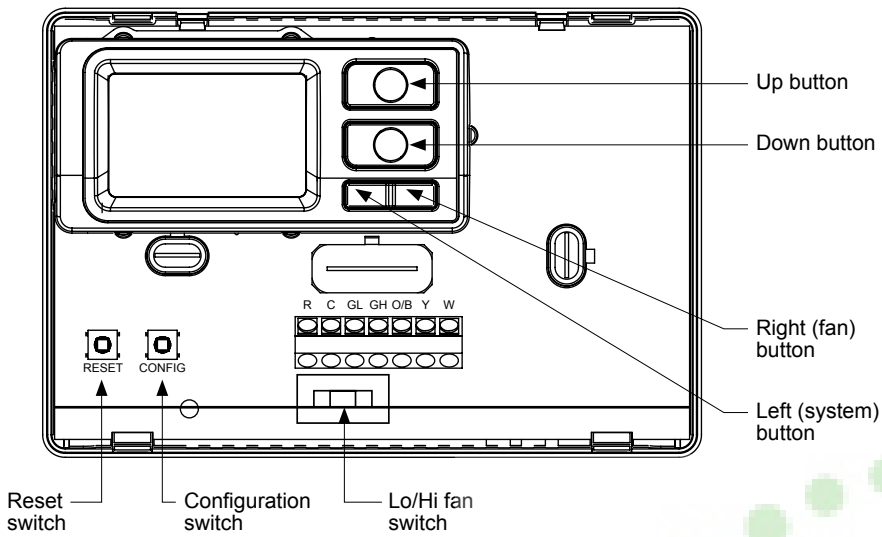

Icon Descriptions

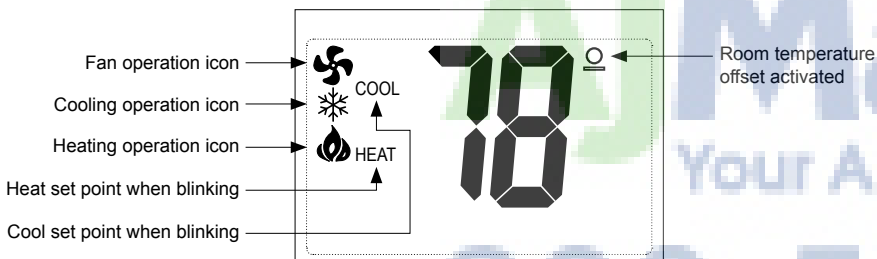

Specifications

- Electrical rating:** • 24 VAC (18-30 VAC)
• 1 amp maximum per terminal
• 3 amp maximum total load
- Temperature control range:** 45°F to 90°F (7°C to 32°C) **Accuracy:** ± 1°F (± 0.5°C)
- System configurations:** 2-stage heat, 1-stage cool, heat pump, electric
- Timing:** Anti-short Cycle: 4 minutes (bypass anti-short cycle delay by returning to OFF mode for 5 seconds)
Backlight Operation: 10 seconds
- Terminations:** R, C, GL, GH, O/B, Y, W

Important Safety Information

- WARNING!** Always turn off power at the main power supply before installing, cleaning, or removing thermostat.
- This thermostat is for 24 VAC applications only; do not use on voltages over 30 VAC
 - All wiring must conform to local and national electrical and building codes
 - Do not use air conditioning when the outdoor temperature is below 50 degrees; this can damage your A/C system and cause personal injuries
 - Use this thermostat only as described in this manual

Package Contents/Tools Required

- Package includes:** RT6 thermostat on base, thermostat cover, wiring labels, screws and wall anchors, Installation, Operation and Application Guide
- Tools required for installation:** Drill with 3/16" bit, hammer, screwdriver

To Remove Existing Thermostat

- ELECTRICAL SHOCK HAZARD – Turn off power at the main service panel by removing the fuse or switching the appropriate circuit breaker to the OFF position before removing the existing thermostat.**
1. Turn off power to the heating and cooling system by removing the fuse or switching the appropriate circuit breaker off.
 2. Remove cover of old thermostat. This should expose the wires.
 3. Label the existing wires with the enclosed wire labels before removing wires.
 4. After labeling wires, remove wires from wire terminals.
 5. Remove existing thermostat base from wall.
 6. Refer to the following section for instructions on how to install this thermostat.

To Install Thermostat

- ELECTRICAL SHOCK HAZARD – Turn off power at the main service panel by removing the fuse or switching the appropriate circuit breaker to the OFF position before removing the existing thermostat.**
- IMPORTANT!** Thermostat installation must conform to local and national building and electrical codes and ordinances.
- ** Note:** Mount the thermostat about five feet above the floor. Do not mount the thermostat on an outside wall, in direct sunlight, behind a door, or in an area affected by a vent or duct.
1. Turn off power to the heating and cooling system by removing the fuse or switching the appropriate circuit breaker off.
 2. To remove cover, pull gently at the seam at the top.
 3. Put thermostat base against the wall where you plan to mount it (Be sure wires will feed through the wire opening in the base of the thermostat).
 4. Mark the placement of the mounting holes.
 5. Set thermostat base and cover away from working area.
 6. Using a 3/16" drill bit, drill holes in the places you have marked for mounting.
 7. Use a hammer to tap supplied anchors in mounting holes.
 8. Align thermostat base with mounting holes and feed the control wires through slit in thermal intrusion barrier and into wire opening.
 9. Use supplied screws to mount thermostat base to wall.
 10. Insert stripped, labeled wires in matching wire terminals.
- CAUTION!** Be sure exposed portion of wires does not touch other wires.
11. Gently tug wire to be sure of proper connection. Double check that each wire is connected to the proper terminal.
 12. Turn on power to the system at the main service panel.
 13. Configure thermostat to match the type of system you have.
 14. Replace cover on thermostat by snapping it in place.
 15. Test thermostat operation as described in "Testing the Thermostat".

Wiring Diagrams

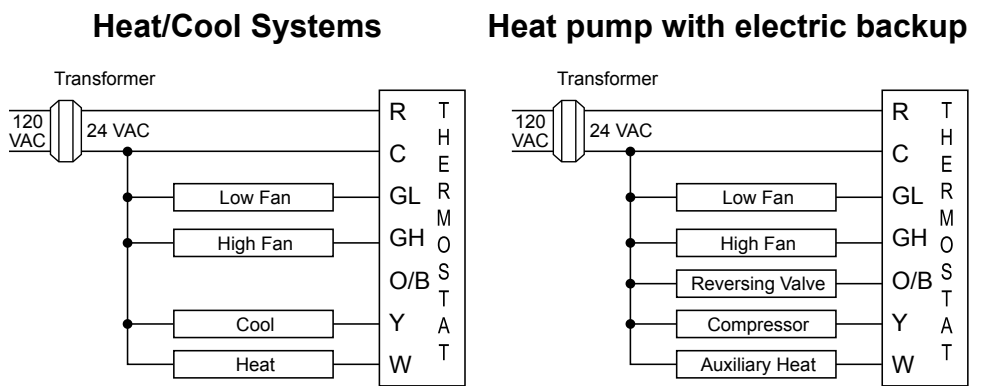

Terminal Designator Descriptions

- R – 24 VAC hot
- C – 24 VAC common
- O/B – Configurable
- O – Cool active reversing valve (Friedrich PTHP)
- B – Heat active reversing valve (Friedrich Vert-I-Pak, Kuhl+HP)
- Y – 1st stage cool, 1st stage heat for heat pumps
- W – 1st stage heat for non-heat pump systems, auxiliary heat for HP systems
- GL – Low fan
- GH – High fan

RT6 Output Chart

Configuration	1 ST Cool	1 ST Heat	2 ND Heat
Heat/Cool and single stage HP models	ELC	Y, G	W, G, B
PDH (PTHP) models only	HP 'O' Config	Y, G, O	Y, G

The RT6 thermostat is configurable for different systems. The configuration directly affects the outputs. Use the output chart to correctly configure and wire the thermostat to your system.

Configuration Mode

- The configuration mode is used to set the RT6 to match your heating/cooling system. The RT6 functions with heat pump, air conditioning, or electric heat systems.
- ** Note:** Thermostat comes configured for 1-stage heat / 1-stage cooling for use with all heat/cool and single-stage heat pump models. For Friedrich PTHP models follow the instructions below to configure the thermostat for two-stage heat pump operation using the 'O' terminal.

To configure the RT6, perform the following steps:

1. Verify the RT6 is in the OFF mode.
Press the **SYS** (left) button until off mode displays.
2. Remove the cover of the thermostat by gently pulling near one of the corners at the top of the thermostat.
3. Press the **CONFIG** button for 1 second while the RT6 is in OFF mode.

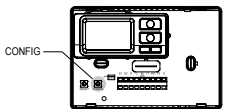
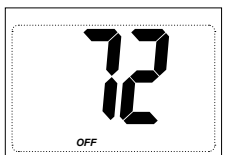

Press the **up** or **down** button to change settings within each screen.

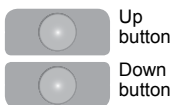

Press the **right** button to advance to the next screen.

**** Note:** Pressing the **left** button will return you to the previous screen.

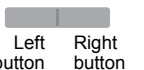

To exit configuration mode, press the **CONFIG** switch for 1 second.

Configuration Mode Settings

The setup screens for Configuration Mode are as follows:

- System** – Set for heat pump, non-heat pump, reversing valve operation

System	Setting	Reversing Valve Setting	Friedrich Models
Heat Pump	HP	O - Energized in Cooling	PDH (PTHP) Only
Heat/Cool and Single-Stage Heat Pump Only	ELC	N/A	VEA, PDE (PTAC), Kuhl+

Press the **up** or **down** button to select.
Press the **right** button to advance to the next screen.



- Temperature Scale** (F or C)

Choose Fahrenheit or Celsius.

Press the **up** or **down** button to select.

Press the **right** button to advance to the next screen.

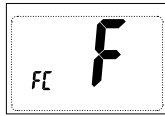

- 1st Stage Temperature Differential** (1°F to 5°F) (0.5°C to 2.5°C)

Set the number of degrees between your "setpoint" temperature and your "turn on" temperature.

Press the **up** or **down** button to set differential value.

Press the **right** button to advance to the next screen.

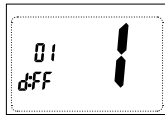

- 2nd Stage Temperature Differential** (1°F to 5°F) (0.5°C to 2.5°C) *(For HP 0 only)*

Set the number of degrees between when stage 1 turns on and when stage 2 turns on.

Press the **up** or **down** button to set differential value.

Press the **right** button to advance to the next screen.



- Staged Off Outputs** *(For HP 0 only)*

Select whether the outputs for heating and cooling are staged off independently or are satisfied simultaneously.

1 = outputs staged off independently

0 = outputs off simultaneously

Press the **up** or **down** button to set.

Press the **right** button to advance to the next screen.

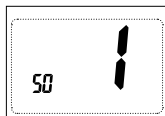

- Auxiliary Delay ON** – (0-30 minutes) *(For HP 0 only)*

Set the delay time in minutes for auxiliary heat to be locked out after a call for second stage. This extra savings feature is used to temporarily lock out auxiliary heat devices, allowing just heat pump to try to satisfy heat call.

Press the **up** or **down** button to select.

Press the **right** button to advance to the next screen.

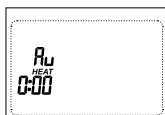

- Maximum Heat Setpoint** (45°F to 90°F) (7°C to 32°C)

Adjust to control the maximum heat set temperature allowed.

Press the **up** or **down** button to select.

Press the **right** button to advance to the next screen.



- Minimum Cool Setpoint** (45°F to 90°F) (7°C to 32°C)

Adjust to control the minimum cool set temperature allowed.

Press the **up** or **down** button to select.

Press the **right** button to advance to the next screen.



- Room Temperature Offset** (+9°F to -9°F) (+4.5°C to -4.5°C)

Adjust to calibrate displayed room temperature to match actual room temperature.

**** Note:** When not set to 0, 0 will display.

Press the **up** or **down** button to select.

Press the **right** button to advance to the next screen.



Mode of Operation

The **RT6** is a 1-stage or 2-stage heat thermostat. It functions with air conditioning, heat pumps, or electric heat systems.

The thermostat activates the heating appliance when the room temperature is below the set heat temperature (by the differential temperature). The **RT6** will stop outputting when the call for heat has been satisfied. With heat pumps, the thermostat will not let the compressor come on for 4 minutes after it turns off. This protects your compressor.

When the room temperature is greater than the set cool temperature (by the differential temperature), the cooling device is activated. The **RT6** will stop outputting when the call for cooling is satisfied. The thermostat will not let the compressor come on for 4 minutes after it turns off. This protects your compressor.

The **RT6** has three possible operating modes: **OFF**, **Heat**, and **Cool** mode. In off mode, the thermostat will not turn on heating or cooling devices. The manual fan can be turned on in all operating modes using the fan button. In heat mode, the thermostat controls the heating system. In the cool mode, the thermostat controls the cooling system.

Button Functions

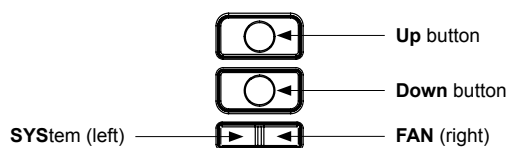

UP – Used to increase the set temperatures and to adjust configuration settings.

DOWN – Used to decrease the set temperatures and to adjust configuration settings.

SYS (left) – Used to change from OFF, HEAT, and COOL modes

FAN (right) – Used to turn on and off the indoor fan.

Operating Modes

There are three possible operating modes for the **RT6**. Off, Heat, and Cool modes are accessed by pressing the **SYS** (left) button.

OFF Mode

- In this mode, the thermostat will not turn on the heating or cooling devices

**** Note:** The indoor fan can be turned on manually in every operating mode by pressing the **FAN** (right) button. The word **FAN** shows on the display and the fan icon  appears when the fan operates.

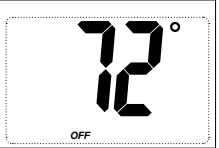

Heat Mode

- In this mode, the thermostat controls the heating system. When the heat outputs, the flame icon  appears on the display.

**** Note:** For heat pumps, there is a four minute delay for your compressor to restart after it has turned off. To bypass the compressor time delay, go to OFF mode for 5 seconds.

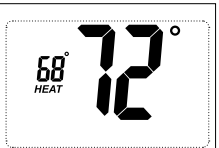

Cool Mode

- In this mode, the thermostat controls the cooling system. When the cooling outputs, the snowflake icon  appears on the display.

**** Note:** There is a four minute delay for your compressor to restart after it has turned off. To bypass the compressor time delay, go to OFF mode for 5 seconds.



Set Point Adjustment

Heat Set Point

- Use the **SYS** button to select Heat Mode. Press the up or down button to view the current heat set point larger on the display. When the large set point is displayed, the **HEAT** icon will blink. The up or down buttons can be used to adjust the set point. After 5 seconds of inactivity the screen will display the room temperature and the **HEAT** icon will not blink.

HEAT icon will blink.

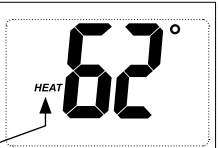

Cool Set Point

- Use the **SYS** button to select Cool Mode. Press the up or down button to view the current cool set point larger on the display. When the large set point is displayed, the **COOL** icon will blink. The up or down buttons can be used to adjust the set point. After 5 seconds of inactivity the screen will display the room temperature and the **COOL** icon will not blink.

COOL icon will blink.

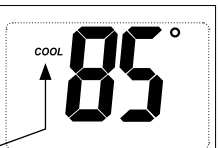

Testing the Thermostat

Once the thermostat is configured, it should be thoroughly tested.

CAUTION! Do not energize the air conditioning system when the outdoor temperature is below 50 degrees. It can result in equipment damage or personal injury.

Heat Test

- Press **SYS** (left) button until heat mode is displayed.
- Adjust the set temperature so it is 5 degrees above the room temperature.
- Heat should come on within a few seconds.
- Adjust the set temperature 2 degrees below the room temperature and the heat should turn off. There may be a fan delay on your system.

**** Note:** For heat pumps, there is a four-minute delay to protect your compressor after it turns off. To bypass the compressor time delay, go to OFF mode for 5 seconds.



Cool Test

- Press **SYS** (left) button until cool mode is displayed.
- Adjust set temperature so it is 5 degrees below room temperature.
- A/C should come on within a few seconds.
- Adjust the set temperature 2 degrees above the room temperature and the A/C should turn off. There may be a fan delay on your system.

**** Note:** There is a four-minute time delay to protect the compressor after it . To bypass the compressor time delay, go to OFF mode for 5 seconds.



Fan Test

- Press **FAN** (right) button. Fan displays. Indoor fan turns ON.
- Press **FAN** (right) button. Indoor fan turns OFF.

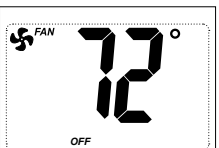

Troubleshooting

Symptom	Remedy
No display	Check for 24 VAC at thermostat; display is blank when 24 VAC is not present
All thermostat buttons are inoperative	Verify 24 VAC is present; unit locks out when 24 VAC is not present
No response with first button press	First button press activates backlight only
Thermostat turns on and off too frequently	Adjust temperature differential (see Configuration Mode Settings 3 & 4)
Fan runs continuously	Press FAN (right) button to turn fan off
Room temperature is not correct	Calibrate thermostat (see Configuration Mode Setting 10)
Heat or Cool not coming on	Verify wiring is correct, gently pull on each wire to verify there is a good connection at terminal block
HEAT blinking	In heat set point screen, this is normal operation
COOL blinking	In cool set point screen, this is normal operation
Problem not listed above	Press Reset button once*

* **Reset Button Function:** Display is refreshed, configuration settings are unchanged.



Friedrich Air Conditioning Co.

Post Office Box 1540 • San Antonio, Texas 78295-1540

4200 N. Pan Am Expressway • San Antonio, Texas 78218-5212

(210) 357-4400 • FAX (210) 357-4480

www.friedrich.com